

## #41080 Barndominium Kit

Available exclusively at [miniatures.com](https://miniatures.com)

Step-by-step assembly instructions

Copyright miniatures.com 2023

### SUPPLIES NEEDED:

Glue (such as Weld Bond #1239)  
Masking tape  
A sharp blade (such as Easy Cutter Ultimate #41134)  
Door and window hardware  
Interior and exterior finishes

**WARNING:**  
**CHOKING HAZARD – Small parts**  
Not for children under 3 yrs.  
Adult supervision required.



### GENERAL INSTRUCTIONS

- Identify and inspect all parts using the Parts List and Parts Diagram.
- Read the directions completely before beginning the project.
- If possible, have a dedicated work area so that you are not unpacking, repacking, and moving the project from place to place.
- Choose a work surface that is level, clean, dry, and protected from spills.
- Do a dry fit, using masking tape to hold parts in place, to make sure everything fits together correctly before assembling permanently.

See [miniatures.com](https://miniatures.com) for finishing ideas and materials

### Tips:

- Plan the finishes for the interior and exterior at the dry-fit stage, before final/permanent assembly. It is easier to finish the panels as flat surfaces. Disassemble and finish as desired, then reassemble using glue.
- References to the left and right sides of the house are from the exterior front perspective, unless noted otherwise.

## Assembly Instructions

### Exterior Shell

Parts you will need in this section:

Front Wall  
Left Wall  
Right Wall  
Ground Floor  
Foundation Rear Wall  
Trim Strips L (2)  
Foundation Slab

1. Place the **Front Wall** flat on the work surface with the inside facing up. The **Front Door** will be towards the left and the beveled top edge will be facing down.
2. Add several lengths of tape on the underside and extending beyond the left and right edges of the wall.
3. Place the **Right Wall** flat on the work surface. Orient it so that the groove is facing up. Place it against the true right side of the **Front Wall** (left side of the **Front Wall** as it rests on the work surface). Refer to the drawing.

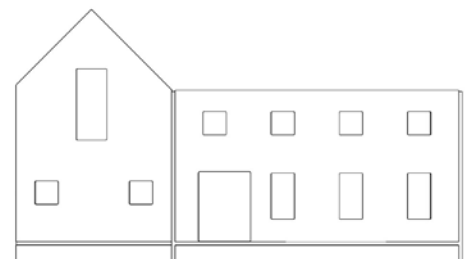

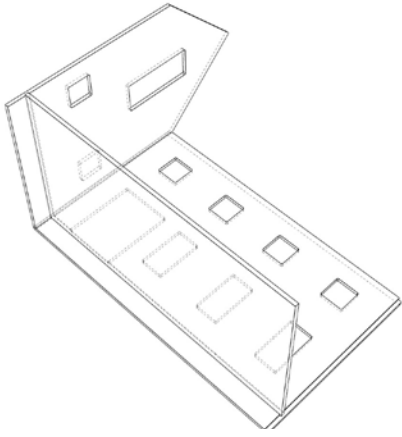

4. Add glue along the rabbet on the **Front Wall** and the grooves on both walls.
5. Place the **Ground Floor** into the groove on the **Front Wall**. Hold the floor in place with one hand.
6. With the other hand, lift the **Right Wall** and fold it against the **Ground Floor**. Refer to the drawing.
7. Assure that the joints are square; tape in place.
8. Repeat Steps 3-7 for the **Left Wall**.

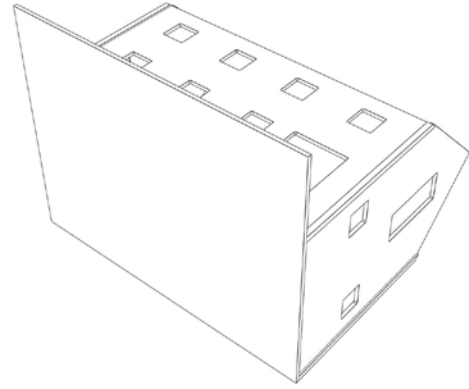

12. Glue and tape the **Foundation Slab** to the bottom of the house. The slab is flush at the back of the house and extends beyond the front and sides. Use **Strips L** as spacers at the bottom of the side walls to assure that the house is centered left and right. Set the **Strips** aside.
13. Let the glue set for a few minutes.

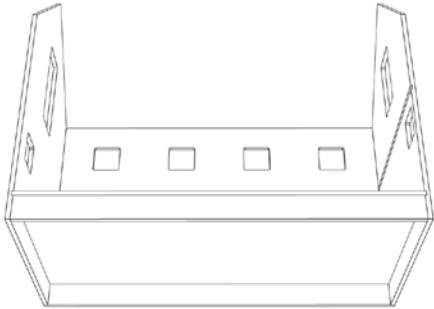

9. Glue and tape the **Foundation Rear Wall** in place. It goes at the rear of the house under the floor and between the side walls. It is flush with the rear edge of the house.
10. Let dry.
11. Turn the house onto its back.

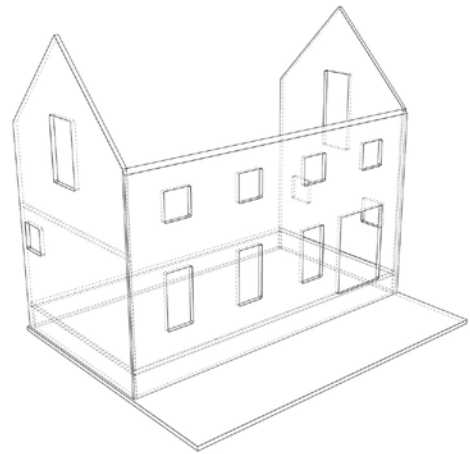

14. Pivot the house upright so that it is resting on the slab. An extra pair of hands is helpful at this stage.
15. Let dry.

## Interior Walls

*Parts you will need in this section:*

Downstairs Wall  
Loft Floor  
Loft Support Post  
Loft Support Beam  
Ceiling Beam  
Upstairs Wall

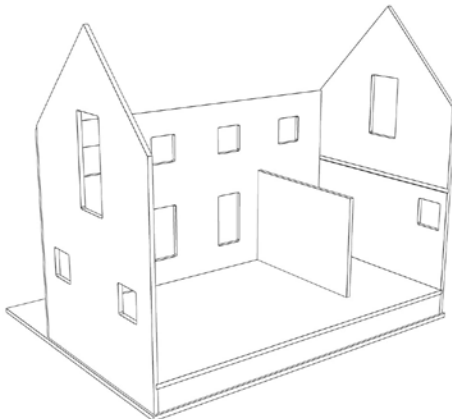

1. Glue and tape the **Downstairs Wall** in place. It goes on the **Ground Floor** and against the **Front Wall**. See drawing. Its exact placement is by preference. Assure that it stands square with the floor and use weights to hold it in place. Let dry.

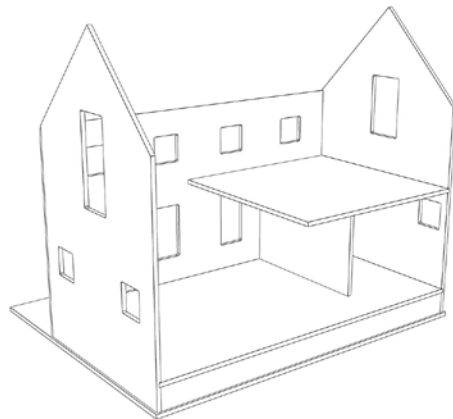

2. Glue the **Loft Floor** in place. It fits into the groove on the **Left Wall**, against the **Front Wall** and rests on top of the **Downstairs Wall**. See drawing. The floor is flush with the **Left Wall**. The floor is slightly wider than deep.



3. Glue the **Support Beam** on top of the **Support Post**. See drawing. The end of the beam is flush with the side of the post. Let dry.

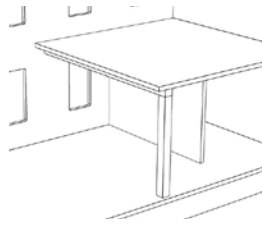

4. Place this support assembly under the **Loft Floor**. See drawing. Its exact placement is by preference. Glue it in place once the interior is decorated.

5. Place the **Ceiling Beam** on the **Loft Floor** against the **Front Wall** and tightly against the **Right Wall**. Mark on the floor where the beam ends. Move the beam to the house's back edge and mark again. Set the beam aside.
6. Orient the **Upstairs Wall** with the door opening closest to the rear of the house. This is by preference.
7. Glue and tape the wall at the marks. Let dry.



## Roof

Parts you will need in this section:  
Front Roof  
Rear Roof

1. Place the **Front Roof** and **Rear Roof** side by side with their beveled edges facing down and touching. Add tape across where the two pieces join.
2. Turn the assembly over and add glue to the beveled edges. Close the pieces together and stand them up like a book. Support the joint by adding tape on the sides up close to the peak. Let the glue set for a few minutes.
3. Place the roof assembly on the house. The edges of the side walls fit into the grooves on the underside of the roof. Support the roof in place with tape. Let dry.
4. Remove the roof. Add glue to the top edges of the front, upstairs and side walls. Do not add glue to the top back edge of the **Upstairs Wall**. Place the roof back on the house. Tape the roof assembly to the house and let dry.

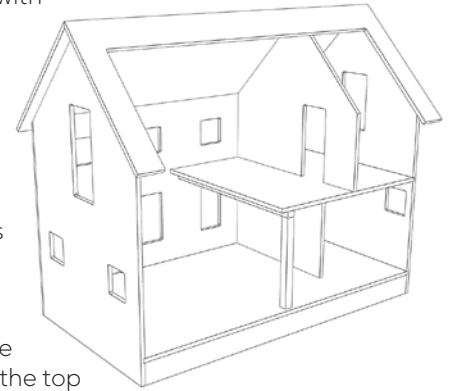

## Cupolas

Parts you will need in this section:  
Cupola Stand (2)  
Cupola Ceiling (2)  
Cupola Floor (2)  
Cupola Gable (4)  
Cupola Roof (4)  
Cupola Window A (4)  
Cupola Window B (4)

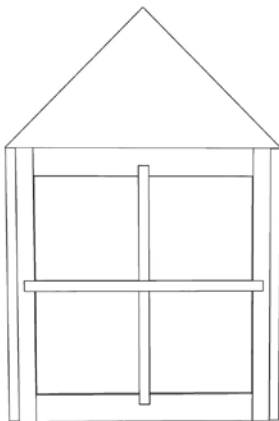

1. Orient Window A with the rabbets to the sides. Glue a **Cupola Gable** to the window at the top. Refer to the drawing. Let dry.
2. Repeat with another gable and window.

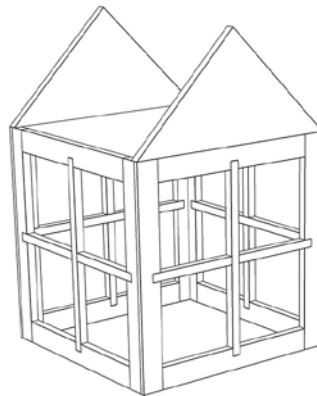

3. Assemble, glue and tape these gable assemblies with a **Cupola Ceiling** and two **Windows B** into the shape of a box. Refer to drawing. Let dry. Put aside.

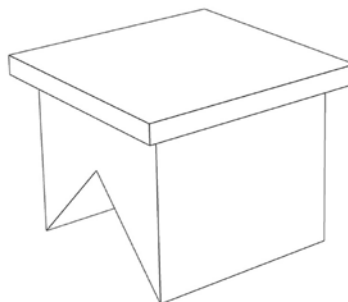

4. Glue and tape a **Cupola Floor** onto a **Cupola Stand**. Assure the pieces are centered.

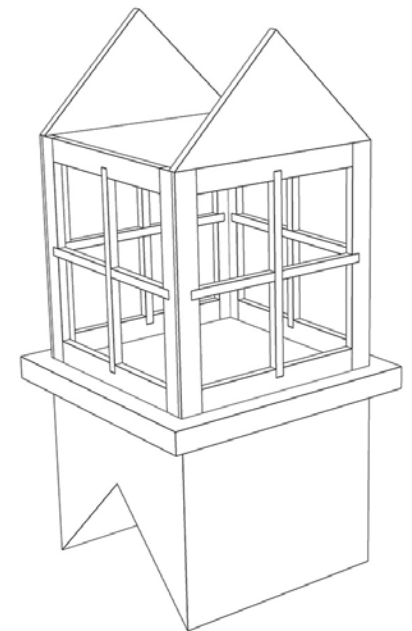

5. Glue and tape the widow assembly on top of the **Cupola Floor**. Assure the pieces are centered. The gables can face forward or to the side by preference.

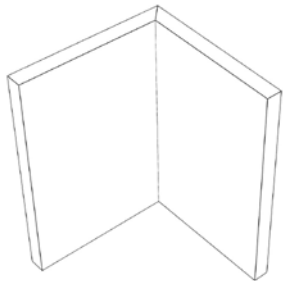

6. Place two **Cupola Rooves** side by side with their beveled edges facing down and touching. Add tape across where the two pieces join.
7. Turn the assembly over and add glue to the beveled edges. Close the pieces together and stand them up like a book. Let dry.
8. Repeat Steps 1-7 for the other cupola.
9. Paint, stain, wire or otherwise finish both cupola assemblies before proceeding.

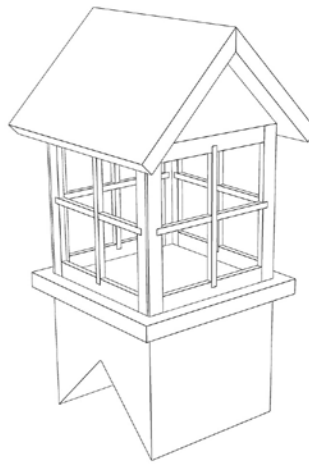

10. Glue and tape the roof assemblies on to the **Cupola Gables**. Assure the pieces are centered and tape.

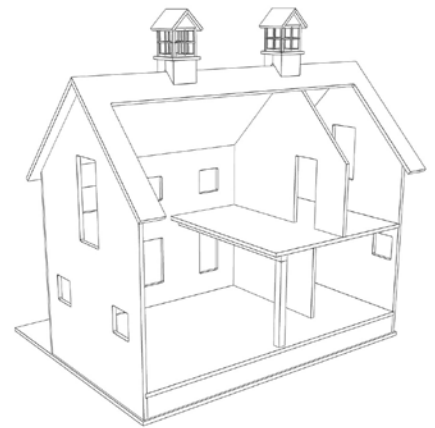

11. Glue both cupolas to the roof. Their exact placement is by preference. Let dry.

## Front Door

*Parts you will need in this section:*  
Front Door

1. Remove both door panes of the **Front Door** by gently pushing the acrylic up and out of the wooden door frames. The top of the frame will come loose.
2. Paint, stain, or otherwise finish the door frames. Let dry.
3. Insert both door panes and tops back into the finished door frames.
4. Glue the **Front Door** into its opening and onto the exterior wall. Note that inside trim is added to the interior wall at a later point.

## Windows

*Parts you will need in this section:*  
Cross Windows (3)  
4-Light Windows (7)  
6-Light Window  
8-Light Window

1. Paint, stain, or otherwise finish all windows. Let dry.
2. Glue all windows into their openings and onto the exterior walls. Note that windowpanes and inside trim are added to the interior walls at a later point.

## Awnings

*Parts you will need in this section:*  
Awning Roof (2)  
Awning Support A (4)  
Awning Support B (4)  
Awning Support C (4)

1. Glue together an **Awning Support A, B** and **C**. See drawing.
2. Glue support assembly to an **Awning Roof** according to the drawing. **Awning Support A** is flush with the angled edge of the **Awning Roof**.
3. Repeat Steps 1 & 2.
4. Paint, stain or otherwise finish the assemblies before proceeding.
5. Glue the awning assemblies to the exterior of the house. They go on either side of the house above the large window and flush with the windows' top and side frames. Orient the assembly so that the angled edge of the **Awning Roof** joins the house.

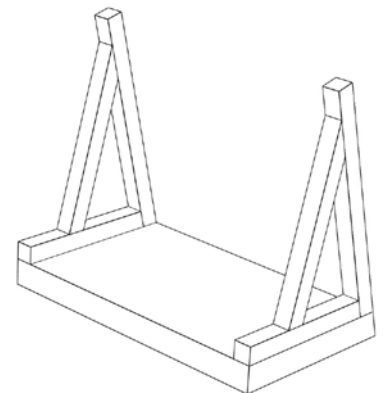
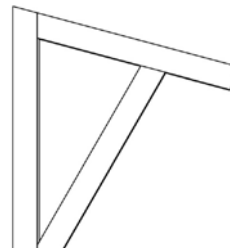

## Corner Trim

*Parts you will need in this section:*  
Corner FL Trim  
Corner FR Trim  
Corner BL Trim  
Corner BR Trim

1. If the corner trim finish will be different from the exterior wall finish, then paint, stain or otherwise finish the corner trim before proceeding.
2. Glue and tape in place the **Corner FL Trim** to the front left corner of the house. The bottom of the trim is flush with the outer edge of the **Foundation Slab** and tucks under the roof eaves.
3. Glue and tape in place the **Corner FR Trim** to the front right corner of the house.
4. Glue and tape in place the **Corner BL Trim** to the back left corner of the house.
5. Glue and tape in place the **Corner BR Trim** to the back right corner of the house.



## Porch

Parts you will need for this section:

- Porch Floor
- Porch Front Base
- Porch Side Bases (2)
- Porch Roof
- Porch Post (4)
- Porch Post Base (4)
- Porch Beam
- Porch Joist (2)
- Porch Rafter (23)
- Porch Stair
- Porch Stair Tread (2)

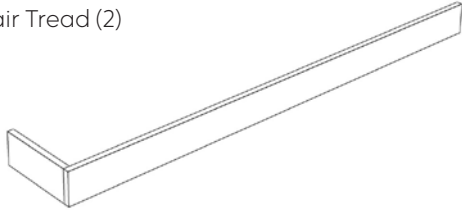

1. Glue and tape a **Side Base** to the **Front Base**. The side butts into the front and its outside surface is flush with the side edge of the front. See drawing.
2. Repeat with the other Side Base.

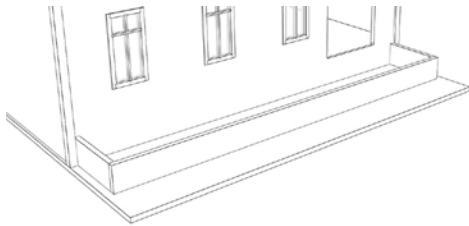

3. Glue and tape the assembly on the **Foundation Slab** against the **Front Wall** and between the **Corner Trim**. Assure the corners are square and let dry.

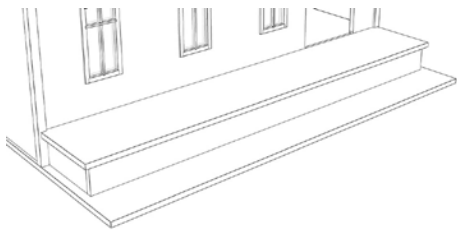

4. Glue and tape the **Porch Floor** to the assembly and **Front Wall** and between the **Corner Trim**.

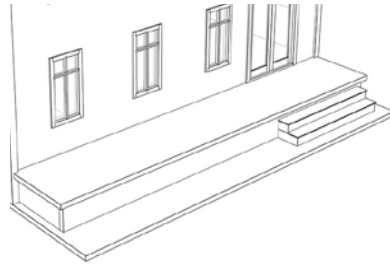

5. Glue the **Porch Stair** to the base assembly and centered with the door.
6. Glue the **Stair Treads** to the stairs.

7. Glue a **Post Base** to a **Porch Post**. The base is centered at the end of the post.
8. Repeat with the remaining three posts and bases.
9. Choose the **Posts'** locations on the porch\*
10. Glue and tape the **Posts** to the **Beam**. The **Beam's** angled side faces up and follows the slope of the roof. Assure that all joints are square. Working on graph paper helps assure alignment.

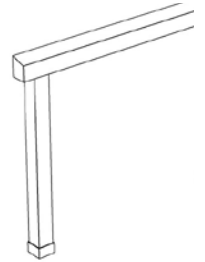

13. Mark on the front edge of the **Beam** 2" in from the left and right edges and every 1 1/2" in between.
14. Center the **Porch Rafters** on these marks. Orient the rafters so that they continue the angle of the top side of the **Beam**.
15. Glue them in place. Let dry. Set the assembly aside.

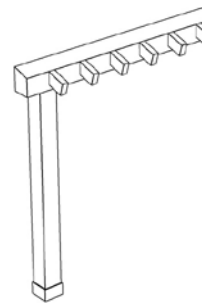

### \* How to choose the posts' locations

- a. Place the **Beam** on the **Porch Floor** and up against the house. Then place two **Posts** flat on the floor, centered on either side of the **Door** and at a right-angles to the **Beam**. Now decide how far apart or close together the **Posts** will be relative to the **Door**. Mark these locations on the **Beam** and tape the **Posts** against the **Beam**.
- b. Measure the right most **Post's** distance from the right edge of the **Beam**.
- c. Place another **Post** at this same distance from the left edge of the **Beam**. Mark and tape the **Post** against the **Beam**.
- d. Measure the distance between the two **Posts** at the **Door**.
- e. Place the last **Post** at this same distance from the left most **Post**. Mark and tape the **Post** against the **Beam**.

## Siding Trim

Parts you will need in this section:

Spacer for Strips  
 Strips A (2)  
 Strips B (38)  
 Strips C (26)  
 Strips D  
 Strips E (30)  
 Strips F (2)  
 Strips G (8)  
 Strips H (18)  
 Strips J (18)  
 Strips K (20)  
 Strips L (4)

- Assure that all exterior windows, cupolas, awnings, and door are secured in place.
- Sufficient strip wood is supplied with the kit to finish the house, while allowing for some waste and error. This assumes that effort is made to cut as many lengths from each wood strip as is reasonably possible.
- Wood strips are oriented so that their widest dimension touches the house and their narrowest dimension stands off the house.
- Measure all sides of the **Spacer** and write these dimensions directly on the spacer. The measurements will be  $1\frac{3}{8}$ ", 1", and  $\frac{1}{2}$ ". The labels provide a quick reference. Use the spacer to establish distance and assure consistency between rib pieces.
- Place strips according to the following table. You may need to make small adjustments. That it is pleasing to your eye is most important.

	Left Edge	Right Edge	Between
Walls	Flush	Flush	1" between strips
Rooves	$1\frac{3}{8}$ " in from edge	$1\frac{3}{8}$ " in from edge	$1\frac{3}{8}$ " pattern repeat, from leading edge to leading edge

### Strip A and Roof Ridge

1. Measure the distances: a) from the right edge of the right cupola to the right roof edge, b) between the two cupolas, and c) left edge of the left cupola to the left roof edge.
2. Cut both **Strips A** into these three lengths for 6 total pieces.
3. Glue the lengths in place. They go on the **Front** and **Rear Roofs** at the very top. See drawing.

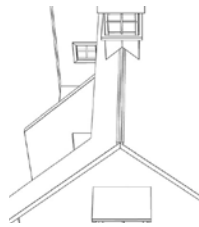

3. Measure the distance from the cupola down to the edge of the roof. Cut sufficient **Strips C** at this length to fill the space. The cut can be angled to account for the pitch of the roof if desired.

### Strips B and Front Roof

1. Glue and tape **Strips B** to the **Front Roof**. Begin by gluing and taping a strip flush with the right most edge of the roof and flush with **Strip A** at the peak of the roof. Repeat this at the left most edge of the roof.
2. Use the **Spacer** and placement marks when gluing and taping **Strips** across the roof. The 1" side fits between the strips. Adjustments for personal preference can be made.
3. Measure the distance from where the cupola meets the roof down to the edge of the roof. Cut a rib to this length. The cut can be angled to account for the pitch of the roof if desired.



### Strips F & G and Awnings

1. Glue **Strip F** to the **Awning Roof** and against the **Right Wall**. Orient the strip so that its widest dimensions rest on the roof and its narrowest dimension touches the wall. See the drawing.
2. Glue **Strips G** to the **Awning Roof**. Place two flush with the outside edges. Then center the remaining two. See the drawing.
3. Repeat on the left side of the house.



### Strips L and Side Walls

1. Glue a **Strip L** on the **Right Wall** at the very bottom. See drawing. It will be flush with the **Corner Trim** and **Foundation Slab**.
2. Repeat for the **Left Wall**.



### Strips B & C and Rear Roof

1. Glue and tape **Strips B** to the **Rear Roof**.
2. Use **Strips C** where the roof length shortens.



### Strips K & L and Side Walls

1. From the supply of **Strips K**, cut 10 pieces  $11\frac{1}{8}$ " long.
2. Glue these strips to the lower **Left Wall**. Place the spacer over the right **Corner Trim** and the first strip flush against the spacer to create a  $1\frac{3}{8}$ " pattern repeat. Continue using the spacer to help assure consistent placement. Work from right to left.

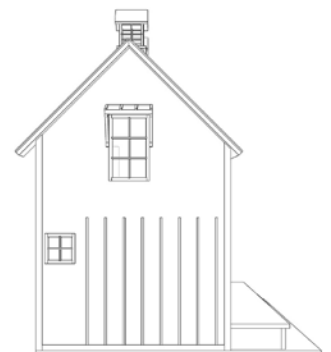

3. Glue another **Strip L** on the **Right Wall** above the 10 installed strip. It is flush with the corner trim and flush with the tops of 10 strips.

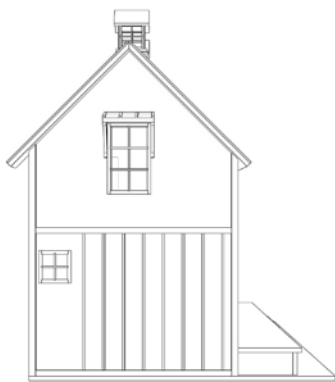

4. Measure the distance from the lower **Strip L** to the bottom edge of the window frame.

5. From the supply of **Strips K** (and scrap pieces), cut 2 strip pieces to the measured length.

6. Glue these 2 strips in place.

7. Measure the distance from the top edge of the window frame up to the upper **Strip L**.

8. From the supply of **Strips K** (and scrap pieces), cut 2 strip pieces to the measured length.

9. Glue these 2 strips in place.

10. Place the spacer against the right **Corner Trim** and measure the distance from the upper **Strip L** to the top of the wall and under the roof eave.

11. From the supply of **Strips K** (and scrap pieces), cut 1 strip piece to the measured length. Cut it at a 45° angle.

12. Glue this strip in place.

13. Continue working in this manner from right to left. Notice that beyond the roof peak the direction of the cut angle changes.

14. Add strip pieces below and above the large window.

15. Repeat on the **Right Wall**.

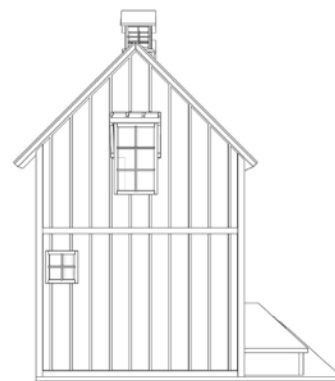
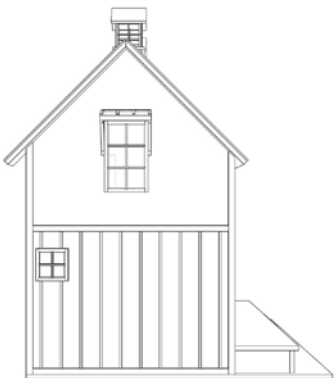

### Strips H and Front Wall

1. Glue and tape **Strips H** to the **Front Wall**. They rest on the **Porch Floor**.
2. Anticipate space for the **Porch Joist** that will be installed next.

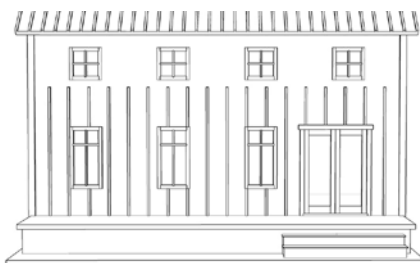

### Porch Beam Installation

1. Stand the **Porch Beam** assembly, from the **Porch** section of these instructions, on the **Porch Floor**.
2. Fit a **Porch Joist** between the left most **Post** and the house. Its exact placement at the top of the post is by preference.
3. Glue and tape.
4. Repeat for the right side.
5. Let dry.

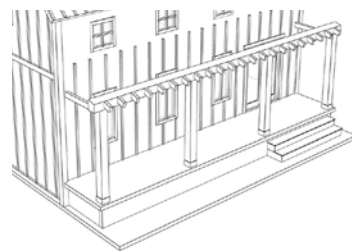

### Porch Roof Installation

1. Glue and tape the **Porch Roof** in place. It rests on the **Porch Beam** assembly, against the house, and on the tips of **Strips H**.

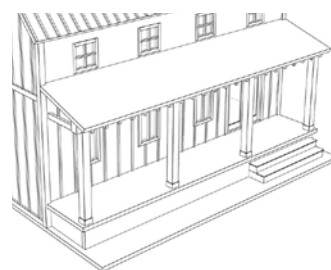

### Strips D & E and Porch Roof

1. Glue and tape **Strip D** to the **Porch Roof** and **Front Wall** and under the **Window Frames**. Notice that it is angled on one side. The angled side meets the wall and follows the slope of the roof.
2. Glue and tape **Strips E** to the **Porch Roof**. The angled end of the **Strip E** touches **Strip D** and faces down.

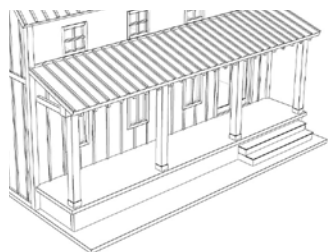
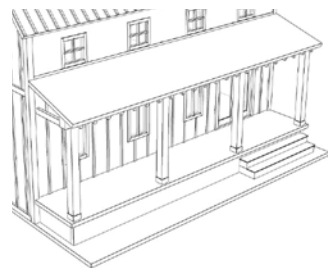

### Strips J and Front Wall

1. Glue and tape **Strips J** to the **Front Wall**. They rest on **Strip D**.



## Interior Trim

Proceed once the interior surfaces have been decorated.

### Ceiling

Parts you will need in this section:

Ceiling Beam  
Ceiling Short Rafters (3)  
Ceiling Long Rafters (3)  
Ceiling Joists (3)

1. Glue and tape a **Short Rafter**, **Long Rafter** and **Joist** together as shown in the drawing. Working on top of graph paper can help assure that the assembly is square.
2. Repeat Step 1 to produce two more assemblies.
3. Let dry.
4. Paint, stain or otherwise finish the rafter assemblies, and **Beam**.
5. Glue and tape one rafter assembly to the ceiling. It touches the **Front Wall**, **Front Roof**, and **Rear Roof**. Orient the assembly so that the **Long Rafter** is towards the front of the house. Center it above a **4-Light Window** and a **Cross Window** that are just below it.
6. Repeat for the other two rafter assemblies.
7. Let dry.
8. Glue and tape the **Beam** in place. It touches the exposed tips of the **Short Rafters** as well as the **Right Wall** and the **Upstairs Wall**.
9. Let dry.

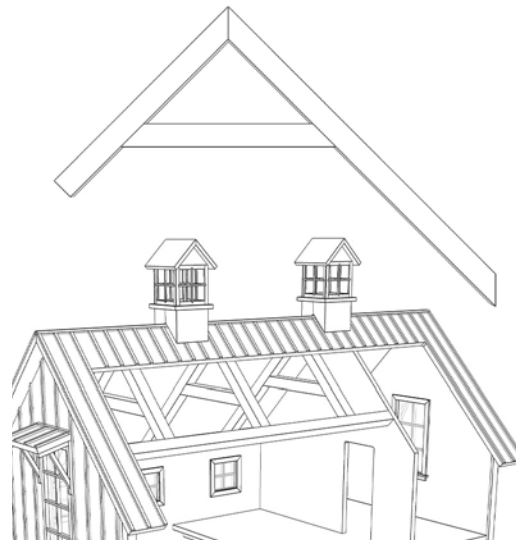

### Loft Railing

Parts you will need in this section:

Middle Baluster (3)  
Side Baluster (4)  
Long Rail (12)  
Short Rail (8)  
Ladder

1. Paint, stain or otherwise finish the parts before assembly.
2. Glue four **Short Rails** into the holes of a **Side Baluster**.
3. Glue the other ends of the rails into the holes on one side of a **Middle Baluster**.
4. Glue four more **Short Rails** into the holes on the other side of that **Middle Baluster**.
5. Glue the other ends of the rails into the holes of another **Side Baluster**.
6. Let dry. Set aside.

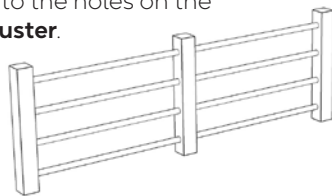

7. Glue four **Long Rails** into the holes of a **Side Baluster**.
8. Glue the other ends of the rails into the holes on one side of a **Middle Baluster**.
9. Glue four more **Long Rails** into the holes on the other side of that **Middle Baluster**.
10. Repeat Steps 8 & 9.
11. Glue the other ends of the rails into the holes of another **Side Baluster**.
12. Let dry.
13. Install the railings and **Ladder**.

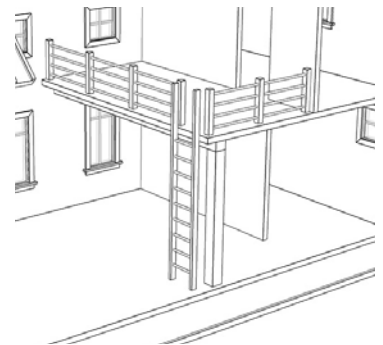

### Barn Door

Parts you will need in this section:

Barn Door  
Track  
Wheels, Plates and Pegs

1. Paint, stain or otherwise finish the parts before assembly. Take care to not plug the holes or excessively coat the pegs.
2. Glue a **Peg** into a hole on each **Plate** pushing it all the way through. Let the glue set for a few minutes.
3. Place the **Barn Door** flat on the work surface with the holes facing up. This is the front of the door.

4. Glue a **Plate** to the door. Align the plate so that its empty hole aligns with a hole in the door while the other hole with the peg already in it rises above the door. Assure the **Plate** is straight. Use a small amount of glue only where the two pieces come in contact.
5. Repeat Step 4.
6. Glue a **Peg** into each of the remaining empty holes, pushing them flush with the **Plates**.
7. Let dry.





8. Turn the door over.
9. Glue the **Wheels** to the very tips of the **Pegs**.

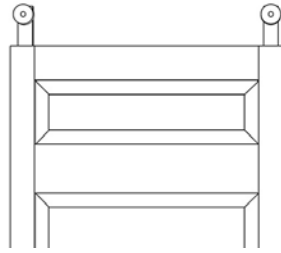

10. Check spacing by gently hooking the **Wheels** into the **Track**. The edge of the **Track** fits between the **Wheels** and **Plates**. The door hangs from the two pegs in the space left between the **Wheels** and **Plates**.

11. Let dry.
12. Glue the **Track** to the **Upstairs Wall**, above the door opening and on the side that is facing the **Ladder**.
13. Hang the assembled door. It will slide from side to side.

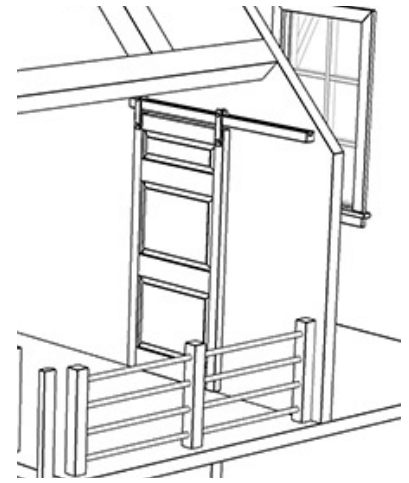

## Window Trim

*Parts you will need in this section:*

Cross Window Trim (12)  
 4-Light Window Trim (28)  
 6-Light Window Trim (4)  
 8-Light Window Trim (4)

1. Place a set of **Cross Window Trim** around a window opening. The sill is centered between the side pieces. Mark where the sides join the sill. Use these marks as a guide when assembling the remaining **Cross Windows**.
2. Repeat Step 1 for the **6-Light** and **8-Light Windows**. This step is not necessary for the **4-Light Windows** because all corners join at the bevel.
3. Assemble, glue and decorate all interior window frames. Working on a graph-paper lined surface makes assembly and installation easier and assures that the frames are square. Even lightly gluing the trim to the paper is beneficial. The paper is trimmed away once the frames are painted and dry. Refer to the drawings.



4. Remove the protective coating from the windowpanes and place the panes in their respective window openings. Glue the interior window frames to the interior walls.

## Door Trim

*Parts you will need in this section:*

Front Door Trim (3)

1. Place the trim pieces around the door opening. The top piece is centered between the side pieces. Mark where the sides join the top.
2. Assemble, glue and decorate the interior door frame on a graph-paper lined surface. Refer to the drawing.
3. Glue the door frame to the interior wall.

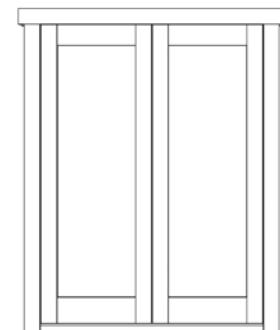

Assembly is now complete.

# Parts List

Dimensions are rounded to nearest fraction of an inch.

## Awning

- (2) Roof -  $2\frac{1}{2}$ "W x  $\frac{3}{8}$ "H x  $4\frac{1}{4}$ "D
- (4) Support A -  $\frac{1}{4}$ "W x  $\frac{1}{4}$ "H x  $3\frac{3}{8}$ "D
- (4) Support B -  $\frac{1}{4}$ "W x  $\frac{1}{4}$ "H x  $2\frac{1}{8}$ "D
- (4) Support C -  $\frac{1}{4}$ "W x  $\frac{1}{4}$ "H x  $2\frac{3}{4}$ "D

## Ceiling

- (1) Beam -  $\frac{3}{4}$ "W x  $\frac{3}{4}$ "H x  $23$ "D
- (3) Short Rafter -  $\frac{3}{4}$ "W x  $\frac{3}{4}$ "H x  $8$ "D
- (3) Long Rafter -  $\frac{3}{4}$ "W x  $\frac{3}{4}$ "H x  $13\frac{1}{32}$ "D
- (3) Joist -  $\frac{3}{4}$ "W x  $\frac{3}{4}$ "H x  $7$ "D

## Cupola

- (4) Stand -  $2\frac{1}{2}$ "W x  $2\frac{1}{2}$ "H x  $2$ "D
- (2) Ceiling -  $2\frac{3}{8}$ "W x  $\frac{1}{8}$ "H x  $2\frac{3}{8}$ "D
- (2) Floor -  $3$ "W x  $\frac{1}{4}$ "H x  $3$ "D
- (4) Gable -  $2\frac{1}{2}$ "W x  $\frac{1}{8}$ "H x  $1\frac{1}{4}$ "D
- (4) Roof -  $3\frac{3}{8}$ "W x  $\frac{1}{4}$ "H x  $2\frac{3}{8}$ "D
- (4) Window A -  $2\frac{1}{2}$ "W x  $\frac{1}{8}$ "H x  $2\frac{1}{2}$ "D
- (4) Window B -  $2\frac{3}{8}$ "W x  $\frac{1}{8}$ "H x  $2\frac{1}{2}$ "D

## Doors

- Front Door
- Barn Door
- Track -  $6\frac{3}{4}$ "W x  $\frac{1}{4}$ "H x  $\frac{1}{4}$ "D
- (2) Wheels
- (2) Plates
- (4) Pegs

## Floors

- Foundation Slab -  $26\frac{1}{8}$ "W x  $\frac{3}{8}$ "H x  $32\frac{1}{2}$ "D
- Ground Floor -  $17\frac{1}{4}$ "W x  $\frac{3}{8}$ "H x  $31\frac{3}{4}$ "D
- Loft Floor -  $17$ "W x  $\frac{3}{8}$ "H x  $17\frac{1}{4}$ "D

## Loft

- Support Post -  $\frac{3}{4}$ "W x  $\frac{3}{4}$ "H x  $8\frac{5}{8}$ "D
- Support Beam -  $\frac{3}{4}$ "W x  $\frac{3}{4}$ "H x  $16\frac{5}{8}$ "D
- (3) Middle Baluster -  $\frac{3}{8}$ "W x  $\frac{3}{8}$ "H x  $2\frac{3}{4}$ "D
- (4) Side Baluster -  $\frac{3}{8}$ "W x  $\frac{3}{8}$ "H x  $2\frac{3}{4}$ "D
- (12) Long Rail -  $\frac{1}{8}$ "W x  $4\frac{3}{8}$ "L
- (8) Short Rail -  $\frac{1}{8}$ "W x  $3\frac{7}{8}$ "L
- Ladder

## Porch

- Floor -  $5\frac{5}{8}$ "W x  $\frac{3}{8}$ "H x  $32$ "D
- Front Base -  $2$ "W x  $\frac{3}{8}$ "H x  $31\frac{1}{4}$ "D
- (2) Side Base -  $2$ "W x  $\frac{3}{8}$ "H x  $5$ "D
- Roof -  $6\frac{3}{4}$ "W x  $\frac{3}{8}$ "H x  $32\frac{1}{2}$ "D
- (4) Post -  $\frac{3}{4}$ "W x  $\frac{3}{4}$ "H x  $8\frac{1}{8}$ "D
- (4) Base -  $\frac{7}{8}$ "W x  $\frac{7}{8}$ "H x  $\frac{1}{2}$ "D
- Beam -  $1$ "W x  $\frac{3}{4}$ "H x  $32\frac{1}{2}$ "D
- (2) Joist -  $\frac{1}{2}$ "W x  $\frac{1}{4}$ "H x  $4\frac{5}{8}$ "D
- (23) Rafter -  $\frac{1}{2}$ "W x  $\frac{1}{4}$ "H x  $\frac{7}{8}$ "D
- Stair -  $2$ "W x  $1\frac{1}{2}$ "H x  $9\frac{5}{8}$ "D
- (2) Stair Tread -  $1\frac{1}{8}$ "W x  $\frac{1}{16}$ "H x  $9\frac{7}{8}$ "D

## Roof

- Front Roof -  $14\frac{3}{8}$ "W x  $\frac{3}{8}$ "H x  $34$ "D
- Rear Roof -  $14\frac{3}{8}$ "W x  $\frac{3}{8}$ "H x  $34$ "D

## Trim

- (12) Cross Window Trim
- (28) 4-Light Window Trim
- (4) 6-Light Window Trim
- (4) 8-Light Window Trim
- Corner FL Trim -  $\frac{9}{16}$ "W x  $\frac{9}{16}$ "H x  $19$ "D
- Corner FR Trim -  $\frac{9}{16}$ "W x  $\frac{9}{16}$ "H x  $19$ "D

- Corner BL Trim -  $\frac{9}{16}$ "W x  $\frac{9}{16}$ "H x  $19\frac{3}{4}$ "D
- Corner BR Trim -  $\frac{9}{16}$ "W x  $\frac{9}{16}$ "H x  $19\frac{3}{4}$ "D
- (3) Front Door Trim
- Spacer for Strips -  $1$ "W x  $\frac{3}{8}$ "H x  $1\frac{3}{8}$ "D
- (2) Strips A -  $\frac{3}{16}$ "W x  $\frac{1}{8}$ "H x  $34$ "D
- (38) Strips B -  $\frac{3}{16}$ "W x  $\frac{1}{8}$ "H x  $14\frac{1}{4}$ "D
- (26) Strips C -  $\frac{3}{16}$ "W x  $\frac{1}{8}$ "H x  $3$ "D
- Strip D -  $\frac{1}{4}$ "W x  $\frac{3}{16}$ "H x  $31\frac{1}{4}$ "D
- (30) Strips E -  $\frac{3}{16}$ "W x  $\frac{1}{8}$ "H x  $6\frac{5}{8}$ "D
- (2) Strips F -  $\frac{3}{16}$ "W x  $\frac{1}{8}$ "H x  $4\frac{1}{4}$ "D
- (8) Strips G -  $\frac{3}{16}$ "W x  $\frac{1}{8}$ "H x  $2\frac{3}{8}$ "D
- (18) Strips H -  $\frac{3}{16}$ "W x  $\frac{1}{8}$ "H x  $11$ "D
- (18) Strips J -  $\frac{3}{16}$ "W x  $\frac{1}{8}$ "H x  $4\frac{1}{2}$ "D
- (20) Strips K -  $\frac{3}{16}$ "W x  $\frac{1}{8}$ "H x  $27\frac{1}{2}$ "D
- (4) Strips L -  $\frac{1}{2}$ "W x  $\frac{3}{16}$ "H x  $16\frac{5}{8}$ "D

## Walls

- Front Wall -  $19$ "W x  $\frac{3}{8}$ "H x  $32$ "D
- Left Wall -  $17\frac{1}{4}$ "W x  $\frac{3}{8}$ "H x  $28$ "D
- Right Wall -  $17\frac{1}{4}$ "W x  $\frac{3}{8}$ "H x  $28$ "D
- Foundation Rear Wall -  $2$ "W x  $\frac{3}{8}$ "H x  $31\frac{1}{4}$ "D
- Downstairs Wall -  $9\frac{3}{8}$ "W x  $\frac{3}{8}$ "H x  $13$ "D
- Upstairs Wall -  $15\frac{1}{2}$ "W x  $\frac{3}{8}$ "H x  $17$ "D

## Windows

- (3) Cross Windows
- (7) 4-Light Windows
- 6-Light Windows
- 8-Light Windows

## Assemblies and component

## Parts Diagram

Note: Not to scale

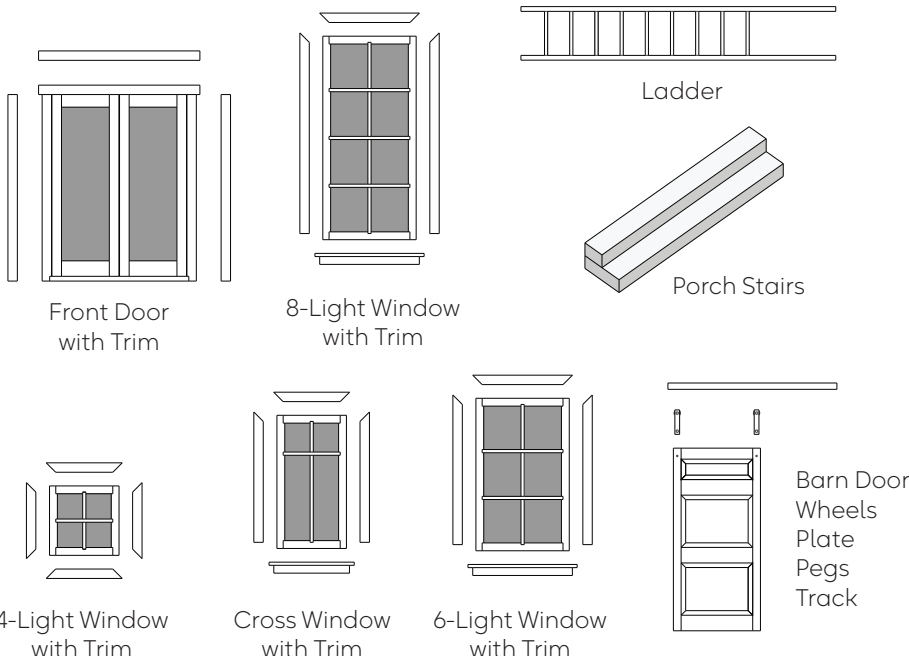

## Barn Door Assembly

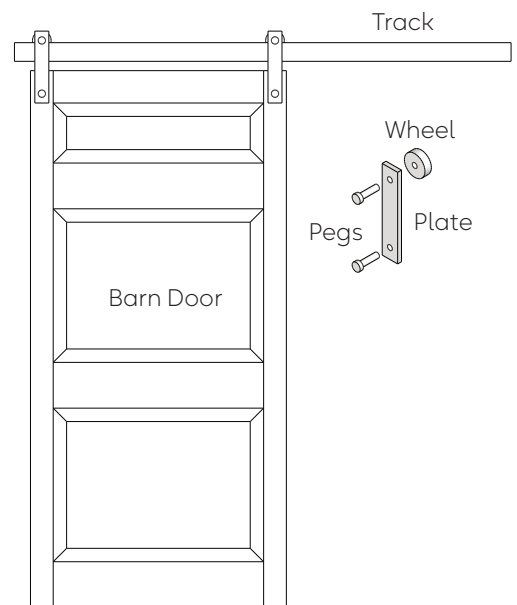

## Porch



Porch Roof



Porch Beam

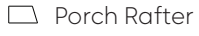

Porch Rafter



Porch Base

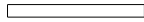

Porch Post



Porch Joist

## Awning



Awning Roof

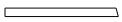

Awning Support A



Awning Support B



Awning Support C

## Railings



Side Baluster

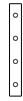

Middle Baluster



Short Rail



Long Rail

## Strips/Corners



Strips A

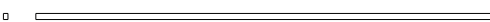

Strips B



Strips C



Strips D



Strips E



Strips F



Strips G

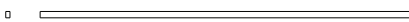

Strips H



Strips J



Strips K



Strips L



Spacer for Strips



Loft Support Post



Porch Stair Tread



Loft Support Beam

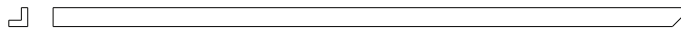

Corner FL Trim

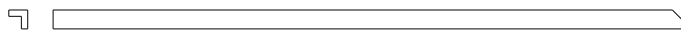

Corner FR Trim



Corner BL Trim



Corner BR Trim

## Cupola

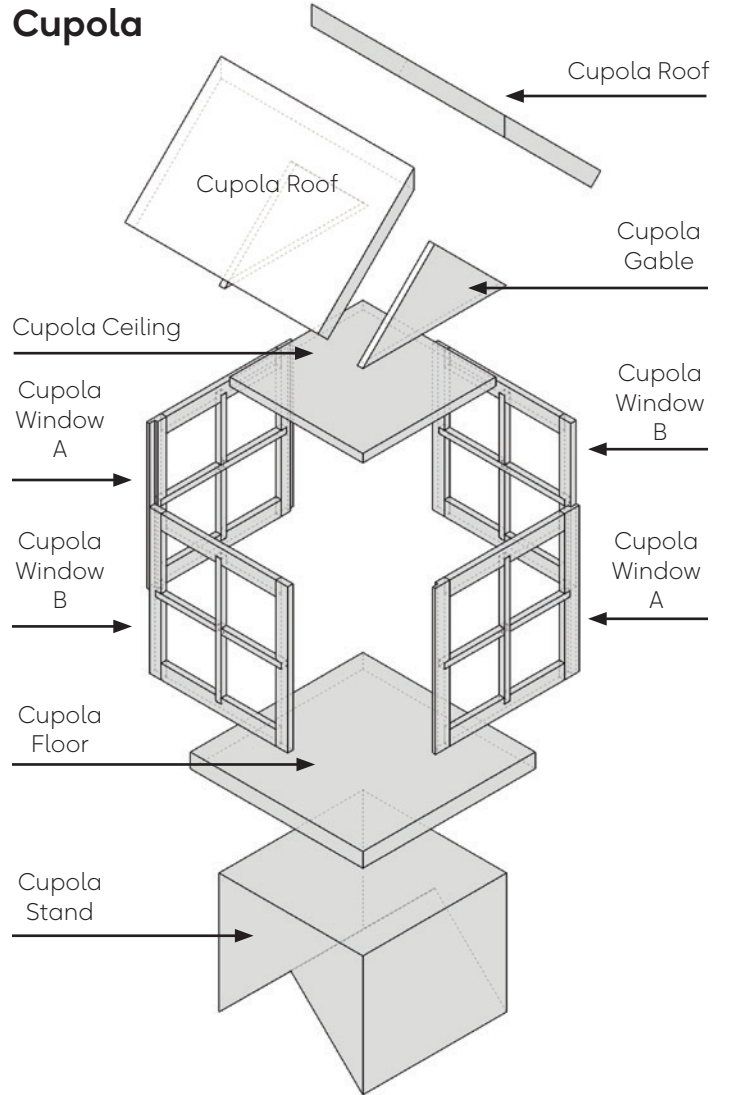

## Floor

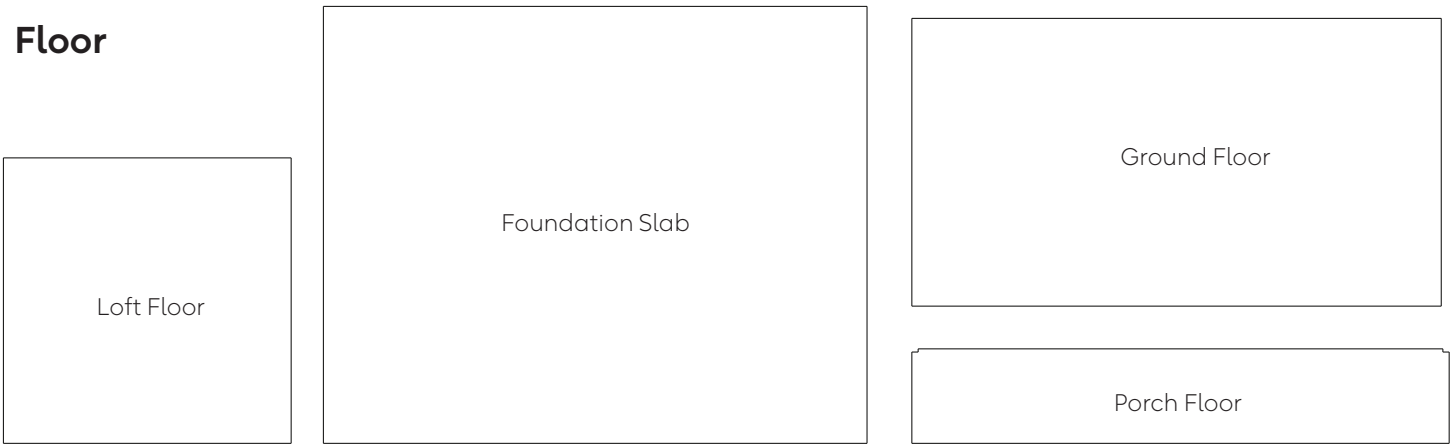

## Wall

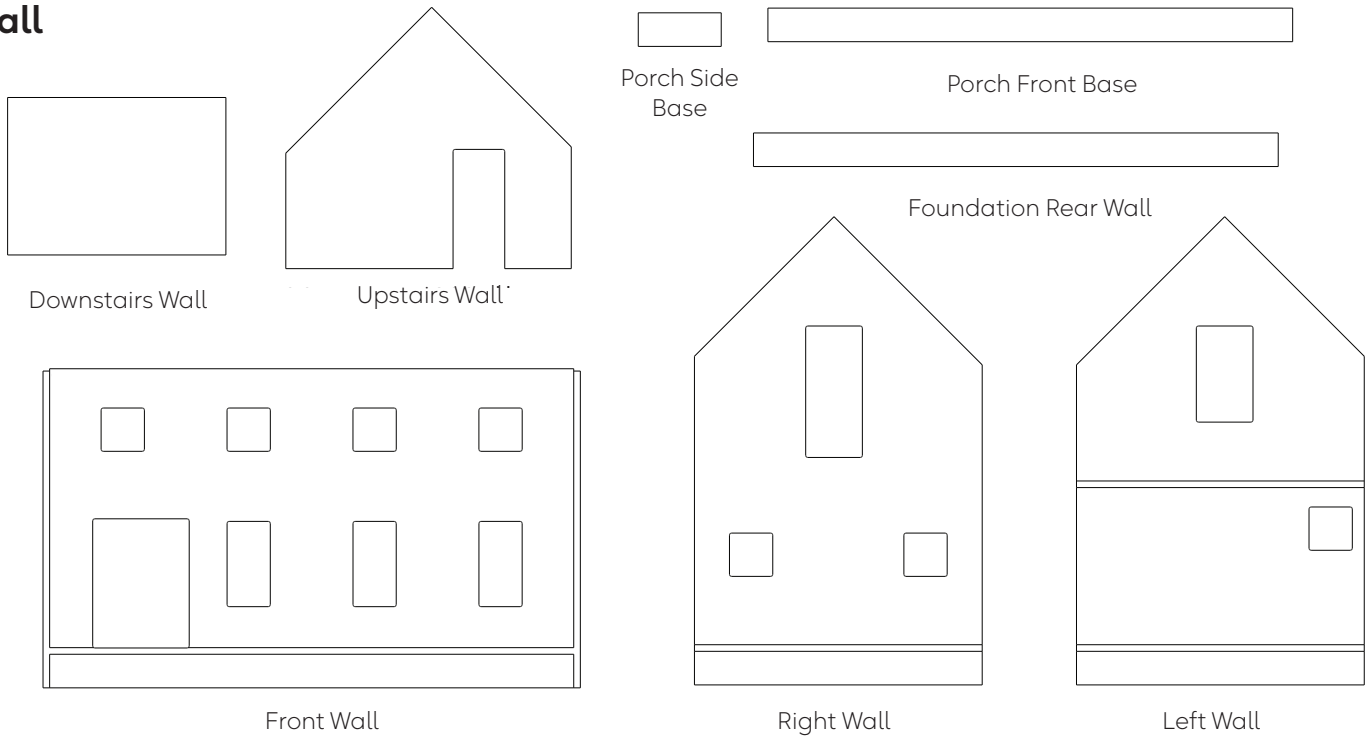

## Main Roof

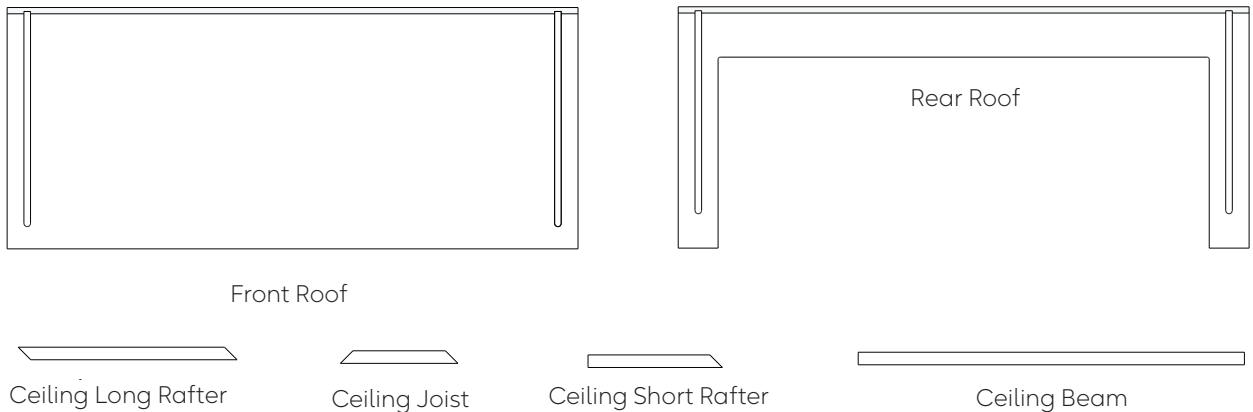

We hope you enjoy your Barndominium Dollhouse kit!  
For finishing tips and more information, visit [miniatures.com](http://miniatures.com).

We would love to see how yours turns out; please send pictures to [support@miniatures.com](mailto:support@miniatures.com).

Questions? Contact us at [support@miniatures.com](mailto:support@miniatures.com) or call 1-800-926-6464 (Mon-Fri 10:00 AM-5:00 PM ET).